

Unit Injector ( EUI-PDE-UIS ) Repair Kits  
VOLVO 2 Pin – 4 Pin Injectors

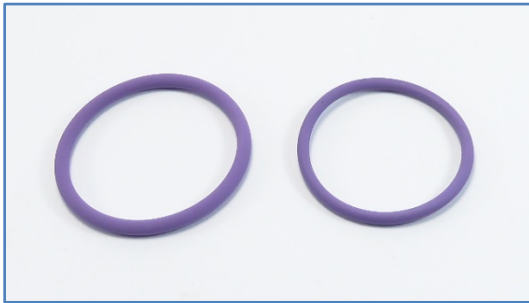

**A1-23162** Repair Kit Volvo EUI

Use = Volvo 2 pin – 4 Pin Delphi Injectors

OEM = 7200-0016 + 7200-0017

OEM = F 00V X99 992 ( Bosch 0 414 702\*\*\* )



**A1-23144** Repair Kit Volvo EUI

Use = Volvo Delphi EUI / Yellow side Actuator

7200-0016 + 7200-0017 + 7200-0014 + 7200-0015

OEM = Volvo 276948



**PRK135-486** Valve Kit Actuator Delphi EUI

Use = Volvo FH Actuator

OEM = 7135-486 ( Valve Used Inside )



**PRK206-0379A**

Actuator Volvo 2 Pin Injectors  
Without Electrical Coil



**PRK206-0379**

Actuator Volvo 2 Pin Injectors  
With Electrical Coil

Unit Injector ( EUI-PDE-UIS ) Repair Kits  
VOLVO 2 Pin – 4 Pin Injectors



**P2-03059** Inj. Sapcer Kit Type Delphi EUI

Use = Volvo FH  
Using Actuator 7135-486

OEM = **7135- 487**



**P2-02039** Inj. Pressure Spring EUI

Use = Volvo / Delphi 4 pin Injectors

OEM = **7207-0070**

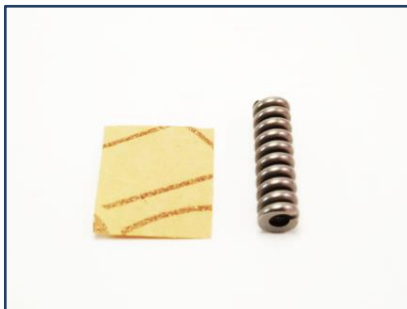

**P2-02032** Inj. Pressure Spring EUI

Use = Volvo / Delphi 2 pin Injectors

OEM = **7169 - 539**



**A1-23294** Repair Kit Volvo

FH Use = Volvo FH

OEM = **7135-488**



**A1-23476** Repair Kit Volvo

FH Use = Volvo FH Actuator

OEM = **7135-476**

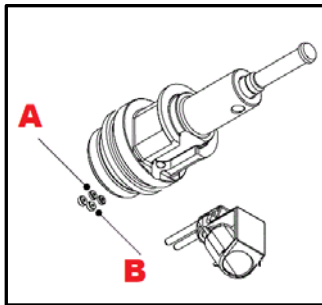

**A4-15579** Backing O'Ring  
Use = Volvo **2 Pin – 4 Pin** Injectors

Oem No : **7204 -0375**

Figure : " A "



**ED4069** Electrical Connector  
Use = Volvo **4 Pin** Injectors

Including 20 cm Cable ( mounted )



**ED4070** Electrical Connector  
Use = Volvo **2 Pin** Injectors

Including 20 cm Cable ( mounted )



**PRK135-588** Actuator Upper Body Kit

Oem No : **7135-588**

Use = Volvo **4 Pin** Injectors



**A4-15299** O'Ring Set

Oem No : **7200-0031**

Use = Volvo **2 Pin** Injectors

John Deere Unit Injector BEBE4B13001

Unit Injector ( EUI-PDE-UIS ) Repair Kits  
DAF Euro5 - Smart

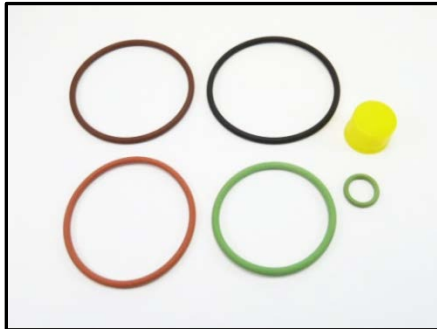

**A1-23717** Repair Kit DAF Euro 5

Use = Injector Daf Euro 5 Delphi Unit Pump

OEM Ref's Included = 7207-0100 / 7200-0027

7200-0070 / 7200-0071 / 7208-0247



**A1-23716** Repair Kit DAF Smart Euro 5

Use = Injector Daf Euro 5 Delphi Smart Injector

OEM Ref's Included = 7200-0118 / 7200-0119

Injectors's Used :

BEBJ1A00001 / BEBJ1A00101

BEBJ1A00201 / BEBJ1A00202

BEBJ1B00001



**A1-23716S** Repair Kit DAF Smart Euro5  
Euro6

Use = Injector Daf Euro 5 Delphi Smart Injector

OEM O'ring Ref's Included :

7200-0118 + 7200-0119 + 7200-0271

Injectors Used : BEBJ1A00001 / BEBJ1A00101

BEBJ1A00201 / BEBJ1A00202

BEBJ1B00001

BEBJ1A05001 / BEBJ1A05002



**A1-23716A** Repair Kit DAF Smart Euro6

Use = Injector Daf Euro 6 Delphi Smart Injector

OEM Ref's Included = 7200-0119 / 7200-0271

Injectors's Used :

BEBJ1A05002

BEBJ1A05001

Unit Injector ( EUI-PDE-UIS ) Repair Kits  
Type Bosch



**A1-23367** Valve

Unit injector Valve

Dia's . 6.995 to 7.040 mm



**A1-23203** Repair Kit EUI Iveco

Use = Iveco Stralis, Eurotracker, Eurotech

Unit Inj. Ref's = 0 414 700 002/ 003

OEM = **F 00V X99 996** Iveco ref : 500350189



**A1-23206** Repair Kit EUI Scania

Use = Scania 1398810 - 1422564

Unit Inj. Ref's = 0 414 701 005 / 007 / 008

OEM = **F 00V X99 999**



**A1-23202** Repair Kit EUI Scania

Use = Scania 1440576 – New Holland 500379769

Unit Inj. Ref's = 0 414 701 006 / 013

OEM = **F 00V X99 995**

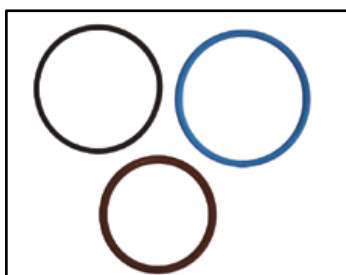

**A1-23718** Repair Kit EUI Scania

Use = IVECO Cursor

0 414 703 004 – 0 414 703 008

OEM = **F 00H 4S0 011**

Unit Injector ( EUI-PDE-UIS ) Repair Kits  
Type Bosch



**A1-23205** Repair Kit EUI Scania

Use = Scania 1731209

OEM = **F 00H N37 928**



**A1-23471** Repair Kit Scania G Series

Use = Scania G series trucks

OEM = **F 00H N37 927 + 928 + F 00V X99 999**



**A1-23210** Repair Kit Scania EUI

Use = Injector Bosch 0 414 701\*\*\*

OEM = **F 00H N37 926 + N37 927 + F 00V X99 999**



**A2-23282** Repair Kit Volvo FH

Use = Volvo FH Body  
0 414 701 004 / 0 414 701 055  
0 414 702 002 / 0 414 702 017

OEM = **F 00V X99 998**

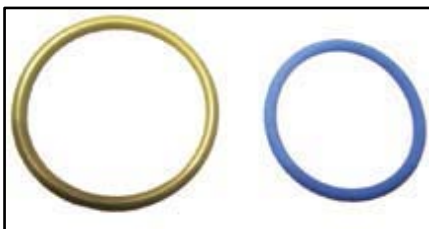

**A2-23432** Repair Kit Volvo FH  
Scania Body 154072 -1766553  
Use : 0 414 701 037 \*\*\*

OEM = **F 00H 4S0 002**

## Unit Injector ( EUI-PDE-UIS ) Repair Kits Type Bosch



### **A2-23431** Repair Kit EUI

Use = Iveco Stralis Euro 5 = 0 414 703 008 - 009  
Iveco EuroTracker = 0 414 703 004

OEM = **F 00H 450 001**



### **A2-24032** Repair Kit EUI

Use = Iveco Stralis 430-480-530 = 0 414 701 013  
Iveco EuroCargo 280-330-350-400 = 0414701 006

OEM = F 00H N37 928 + F 00V X99 998



### **A2-23217** Repair Kit EUI / Universal

Use = Volvo B12 – FH 12  
Use = Iveco Stralis, EuroCargo / Scania

OEM = F 00H N37 928 + F 00V X99 998 +  
F 00V X99 996  
REF Volvo : 276948



### **A2-23213** Repair Kit EUI / Universal

Use = Iveco Stralis, EuroCargo , EuroTech

OEM = F 00H N37 928 + F 00V X99 996

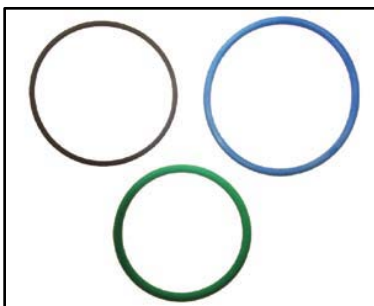

### **A2-23642** Repair Kit EUI

PDE 100S4001/2/4/6

Use = 0 414 703 \*\*\*  
002/003/005/007



Unit Injector ( EUI-PDE-UIS ) Repair Kits  
Type Bosch



**A1-23218** Spring & Pin Kit  
Bosch PDE 90 / 100

Oem No : **F 00H N37 926**



**A1-23433** Spring & Pin Kit  
Bosch PDE 100

Use = 0414703\*\*\*

Oem No : **F 00H 4S0 008**



**P2-03046** Inj. Intermediate Plate EUI

Use = Scania / 1774409

0 414 700 002 ... / 0 414 701 004 .....

OEM = **F 018 B06 804 / F 00Z Z20 003**

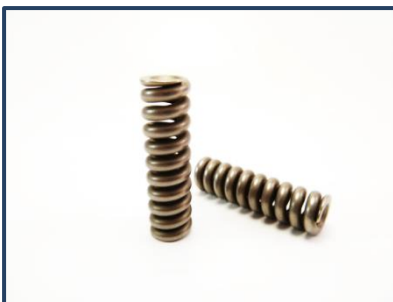

**P2-02027** Inj. Pressure Spring Bosch EUI

Use = Iveco / 0 414 700 008 & Similar Injectors

OEM = **2 434 614 040**



**P2-23028/1** Injector Spacer PDE90 / 100

Use = 0414701\*\* / 702\*\* / 703 \*\*\*

Oem No's : **F 00Z 220 003**

**F 00H N35 703**

Dia : 17.8 x 7 mm



Unit Injector ( EUI-PDE-UIS ) Repair Kits  
Type Bosch



**A1-23420** Piston & Sphere Set

Use : 0414701\*\*\* Bosch Injectors

Oem No : F 00V X99 886



**A1-23419** Piston

Use : IVECO Stralis - Trakker

Oem No : F 00H N36 046



**A1-23422** Piston & Sphere

Use : 0414701005 /\*\*\*

Oem No : F 00V X99 994



**A1-23421** Piston & Sphere

Volvo

Use : 0414702\*\*\* / Bosch Unit Injectors

Oem No : F 00V X99 887



**A1-23391** Plug PDE 90 / 100

**Thickness** : 14,56 – 15,10 mm

Available as sets with various Dia's

Unit Injector ( EUI-PDE-UIS ) Repair Kits  
Type Bosch

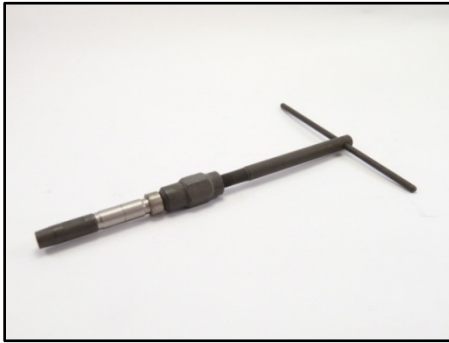

**A1-23430** Reamer for Valve Seat

Unit pump valve seat reamer  
With hand Use  
Longlife durable material

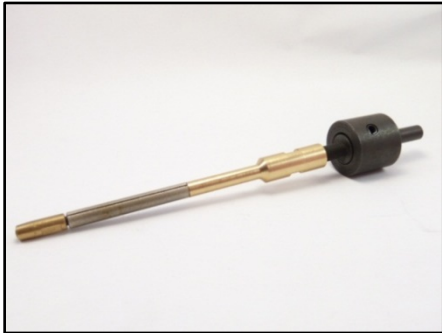

**A1-23365** Reamer for Valve Hole

Unit pump valve holereamer  
With drill use  
Longlife durable material



**A1-23425** Plate

Various sizes  
3.80 mm to 4.00 mm  
+02 mm increase